

G-Cool™ Series Crathco® Beverage Dispensers

Crathco® Dispensador de Bebidas Frías



Grindmaster Corporation

Rayong, Thailand Office

Crathco Ltd.
8/10 Moo 3, Tambon Samnakthon
Amphur Banchang,
Rayong 21130
Thailand
Tel: 66 38 943 223-7
Fax: 66 38 943 229
Crathco@grindmaster.com

Louisville, KY USA Office

4003 Collins Lane
Louisville KY 40245 USA
Tel: (502) 425-4776
(800) 695-4500 (USA & Canada)
Fax: (502) 425-4664
info@grindmaster.com
www.grindmaster.com



GRINDMASTER™
CORPORATION

Basic Machine Parts

Partes Principales de la Máquina

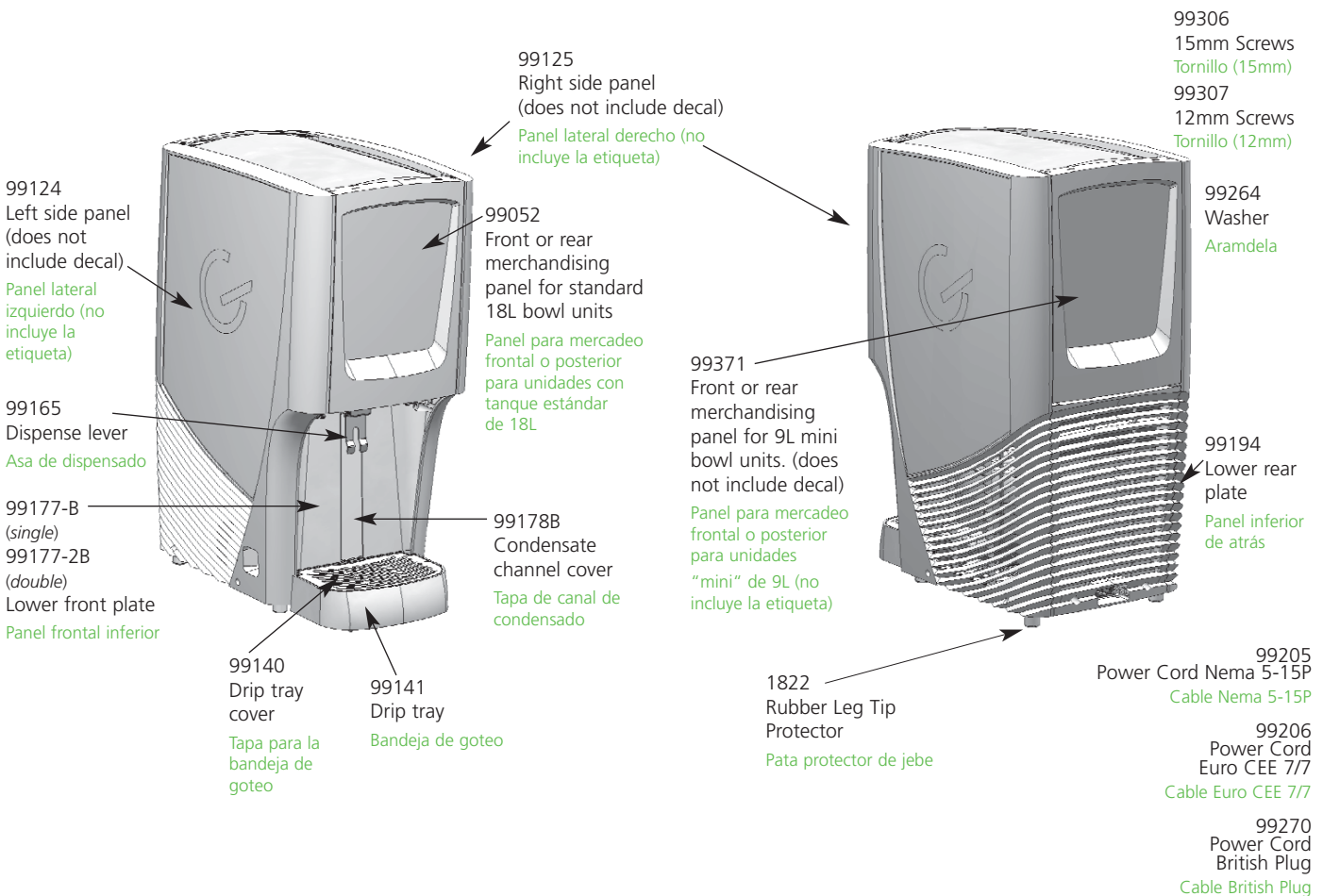
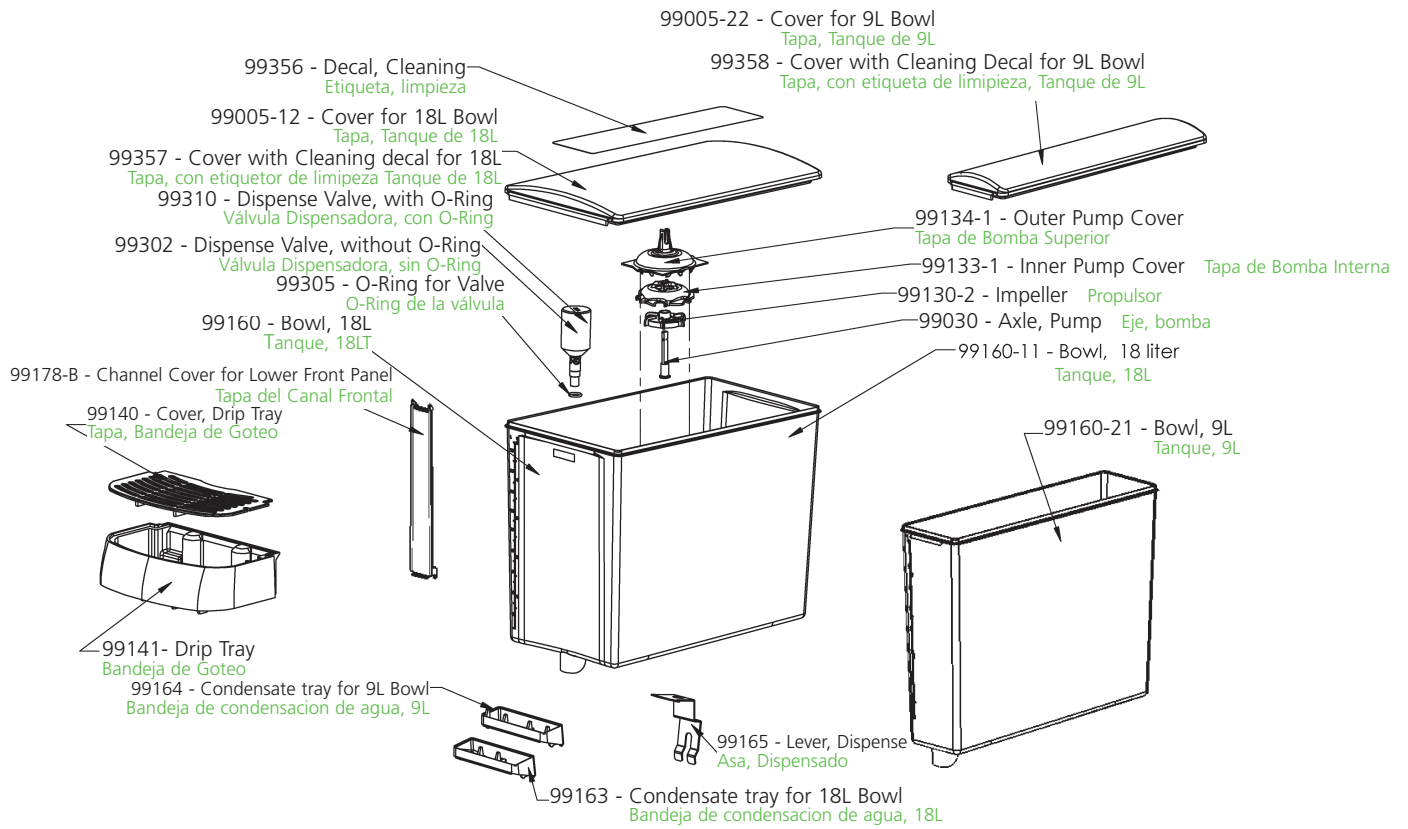

Daily Cleaning Machine Disassembly

Limpeza Diaria Desensamblaje de la Máquina

DAILY/DIARIO					
	1	2	3	4	5
6	7	8	9	10	11
13	14	15	16	17	18
20	21	22	23	24	25
27	28	29	30		



1.

Turn "off" power.
Apague el equipo.

2.

Remove drip tray.
Retire la bandeja de goteo.

3.

Drain bowl.
Drene el tanque.

4.

a. b.

Remove front graphic plate.
Pull lower plate outwards and lift off.
Retire la placa gráfica frontal. Hale la placa de abajo hacia afuera y levántela.

5.

Remove bowl lid.
Retire la tapa del tanque.

6.

Remove bowl.
Retire el tanque.

WARNING! FRAGILE!

Cuidado! Frágil!

Drain bowl completely. Do not lift bowl with liquid inside.
Drene el tanque completamente. No levante el tanque con líquido adentro.

Do not drop bowl.
No deje caer el tanque.

Do not crush bowl.
No presione el tanque.

7.

Remove handle.
Retire el Asa de dispensado.

8.

a. b. c.





a. Unlatch condensation tray.
a. Desmonte la bandeja de condensación.
b. Press and hold panel.
b. Mantenga presionado el panel
c. Remove tray.
c. Retírela

9.

Remove channel cover.
Retire el tapa del canal frontal.

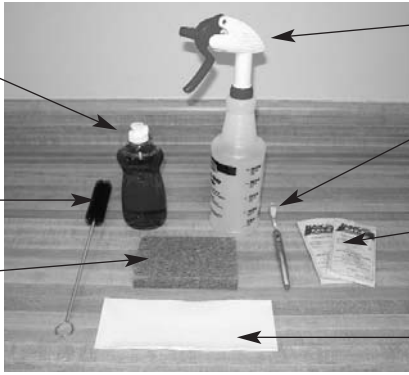
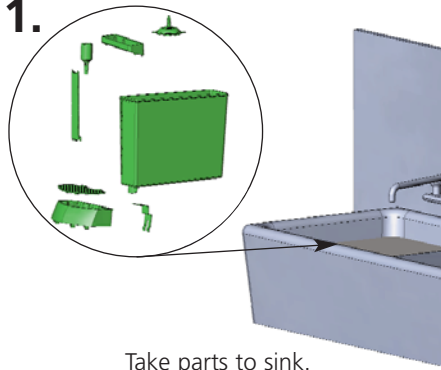
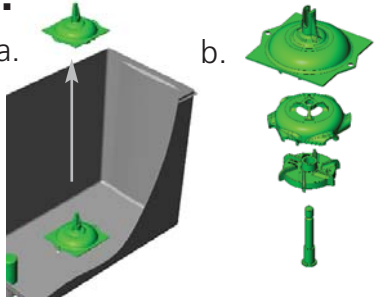
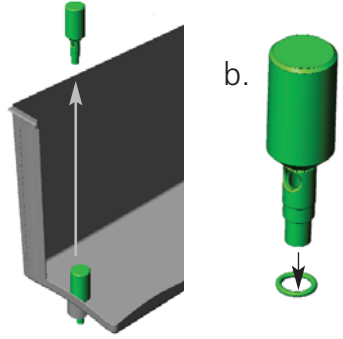
Daily Cleaning (cont.) Cleaning Procedures

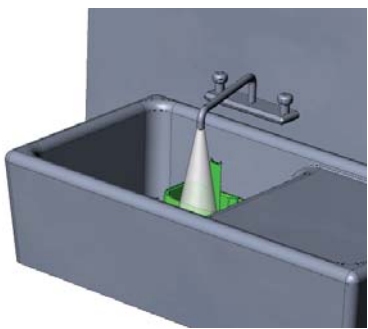
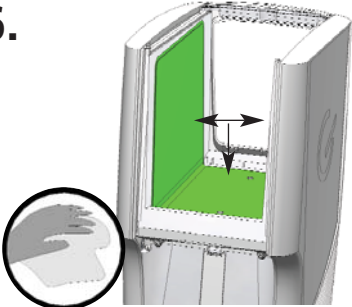
Limpeza Diaria (cont.) Procedimientos de Limpieza

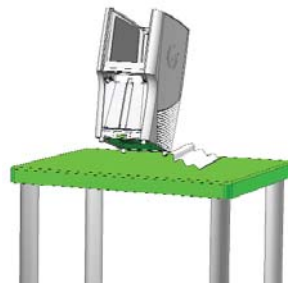
<p>Cleaning Materials & Tools</p> <p>liquid detergent (do not use laundry bar/ powdered detergents) Detergente Líquido (no utilice jabón de lavado/detergentes en polvo)</p> <p>long brush Brocha larga</p> <p>foam/sponge (do not use abrasive) Esponja (no utilice abrasivos)</p>  <p>sprayer Rociador</p> <p>toothbrush Cepillo</p> <p>sanitizer (chlorine based) Desinfectante (a base de cloro)</p> <p>paper towels Papel toalla</p>	<p>1.</p>  <p>Take parts to sink. Lleve las partes al lavadero.</p>	
<p>2.</p>  <p>Remove and dismantle pump assembly. Retire y desmonte el ensamblaje de la bomba.</p>	<p>3.</p>  <p>Lift out dispense valve and remove o-ring. Levante la válvula dispensadora y retire el o-ring.</p>	<p>4.</p> <p>50°C (122°F) Maximum water temperature for cleaning. 50°C (122°F) es la máxima temperatura del agua para limpiar.</p>  <p>75mm (3 inch) Maximum water level for cleaning 75 mm (3 pulgadas) es el máximo nivel del agua para limpieza.</p> <p>Wash with detergent and warm water. Lave con detergente y agua tibia.</p>
<p>5.</p>  <p>Rinse with clean water. Enjuague con agua limpia.</p>	<p>6.</p>  <p>Wipe down evaporator with detergent and warm water. Limpie el evaporador con detergente y agua tibia.</p>	<p>7.</p>  <p>Wipe out condensation tray with detergent and warm water. Limpie la bandeja de condensación con detergente y agua tibia.</p>
<p>8.</p>  <p>Clean channel (a) and front plate (b). Limpie el canal (a) y la placa frontal (b).</p>	<p>9.</p>  <p>Clean counter and bottom part of dispenser with paper towel. Limpie el mostrador y la parte inferior del dispensador con papel toalla.</p>	

Daily Cleaning (cont.)
Daily Sanitizing

Limpieza Diaria (cont.)
Saneamiento Diario

DAILY/DIARIO						
		1	2	3	4	5
6	7	8	9	10	11	12
13	14	15	16	17	18	19
20	21	22	23	24	25	26
27	28	29	30			

1.

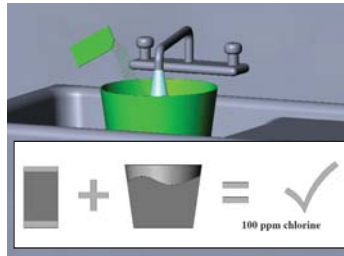

Prepare 8L of chlorine-based sanitizing solution (to 100 ppm) per package instructions.
 Prepare 8L de solución desinfectante con base de cloro (100 ppm) por paquete de instrucción.

2.

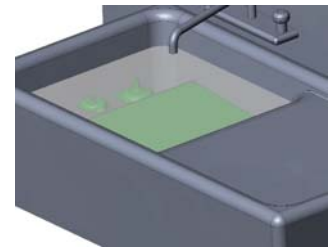

Submerge parts in solution for 15 minutes.
 Sumerja las partes en la solución por 15 minutos.

3.

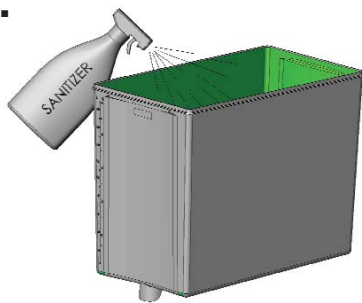

Spray inside of bowl with sanitizer.
 Rocíe dentro del tanque con la solución desinfectante.

4.

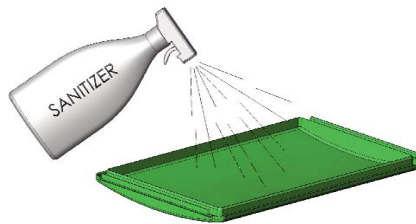

Spray inside of lid with sanitizer.
 Rocíe la tapa del tanque por dentro con la solución desinfectante.

5.

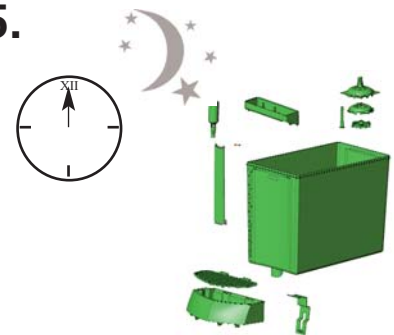

Air dry parts overnight.
 Deje secar las partes durante toda la noche.

Daily Cleaning (cont.)
Machine Reassembly

Limpeza Diaria (cont.)
Reensamblaje de la Máquina

1.

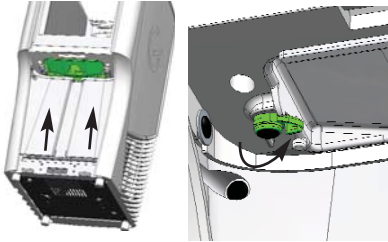

Install condensate tray.
 Instale la bandeja de condensacion.

2.

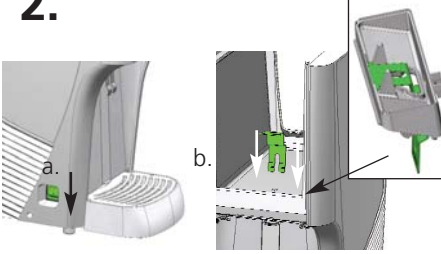

a. Leave machine "OFF"
 Deje la máquina apagada.

b. Install handle.
 Instale el asa.

3. CAUTION / CUIDADO

Sharp edges can cause personal injury.
 Handle with care.
 Los bordes afilados pueden causar heridas personales.
 Manipular con cuidado.

Replace pump axle if flange thickness is less than .75mm (0.03 inch) thick.
 Reemplace el eje de la bomba si el grueso del borde es menor que .75mm (0.03 pulgadas).

Replace impeller if bearing surface is worn.
 Reemplace el propulsor si la superficie del casquillo está gastada.

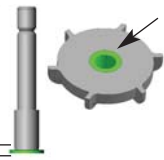

Inspect for wear.
 Revise si está gastada.

4.

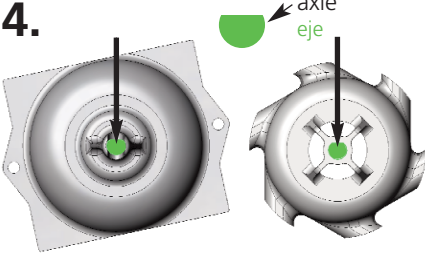

axle
 eje

Pump parts - note flat side.
 Partes de bomba - vea el lado plano.

5.

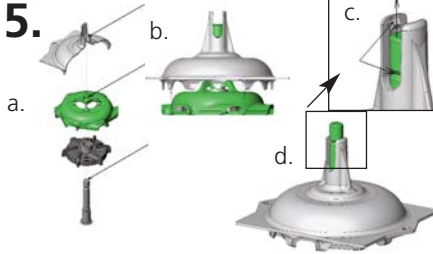

a. b. c. d.

Assemble pump until there is a secure click sound.
 Ensamble la bomba hasta que se escuche un sonido "clic".

6.

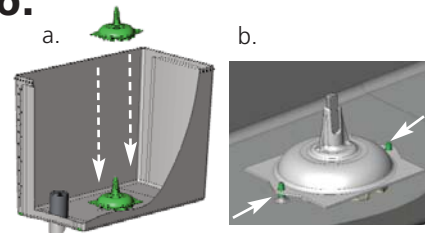

a. b.

Place mixer in bowl.
 Coloque el mezclador en el tanque.

7.

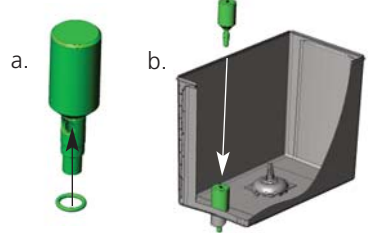

a. b.

Place o-ring on dispense valve (check if nicked or twisted). Place in bowl.
 Coloque el o-ring en la válvula dispensadora (verifique si está astillada o torcida). Coloque el tanque.

8.

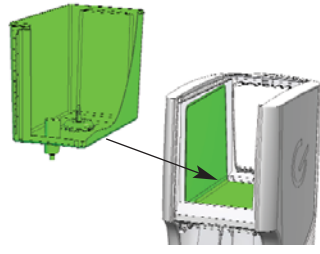

Install assembled bowl.
 Machine must be off.
 Instale el tanque. La máquina debe estar apagada.

9.

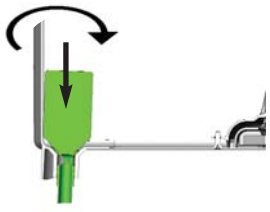

Push and twist valve into place.
 Empuje y gire la válvula en su lugar.

10.

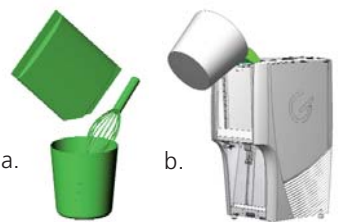

a. b.

Mix product in clean container.
 Fill bowl with product.
 Mezcle el producto en un recipiente limpio.
 Llene el tanque con producto.

11.



Install lid.
 Instale la tapa.

12.

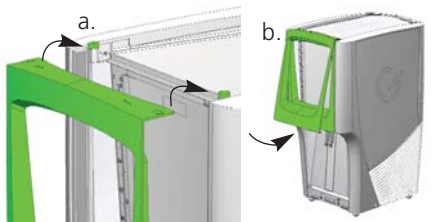

a. b.

Install front graphic plate.
 Instale la placa gráfica frontal.

13.

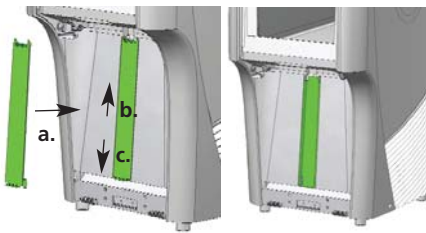

a. b. c.

Install channel.
 Instale el canal.

14.

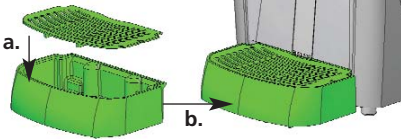

a. b.

Install drip tray.
 Instale la bandeja de goteo.

15.



Turn "on" power.
 Encienda el equipo.

1.

DAILY/DIARIO		1	2	3	4	5
6	7	8	9	10	11	12
13	14	15	16	17	18	19
20	21	22	23	24	25	26
27	28	29	30			

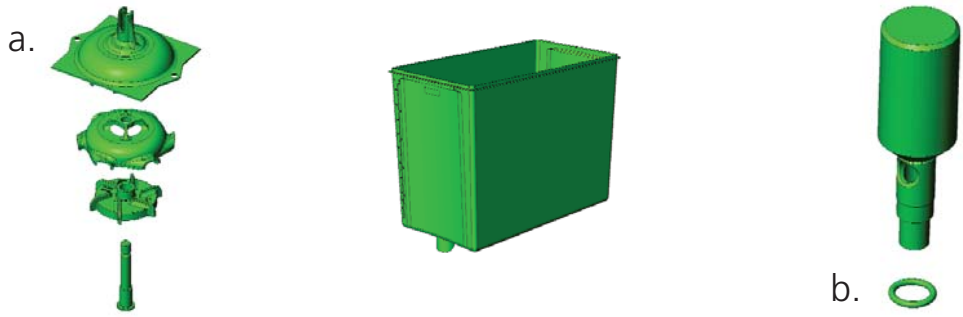

a. Inspect components for wear and tear. Replace if worn or damaged.
 b. Replace o-ring (every six months or as needed).

a. Verifique si los componentes están gastados o rotos. Reemplace si están gastados o dañados.
 b. Reemplace el o-ring (cada seis meses o cuando sea necesario).

2.

DAILY/DIARIO		1	2	3	4	5
6	7	8	9	10	11	12
13	14	15	16	17	18	19
20	21	22	23	24	25	26
27	28	29	30			

CAUTION/ CUIDADO

Sharp edges can cause personal injury. Handle with care.
 Los bordes afilados pueden causar heridas personales.

Replace pump axle if flange thickness is less than .75mm (0.03 inch) thick.
 Reemplace el eje de la bomba si el grosor de los bordes son menor que .75mm (0.03 pulgadas).

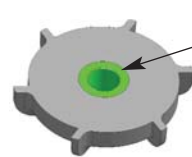

Replace impeller if bearing surface is worn.
 Reemplace el propulsor si la superficie del casquillo está gastada.

3.

DAILY/DIARIO		1	2	3	4	5
6	7	8	9	10	11	12
13	14	15	16	17	18	19
20	21	22	23	24	25	26
27	28	29	30			

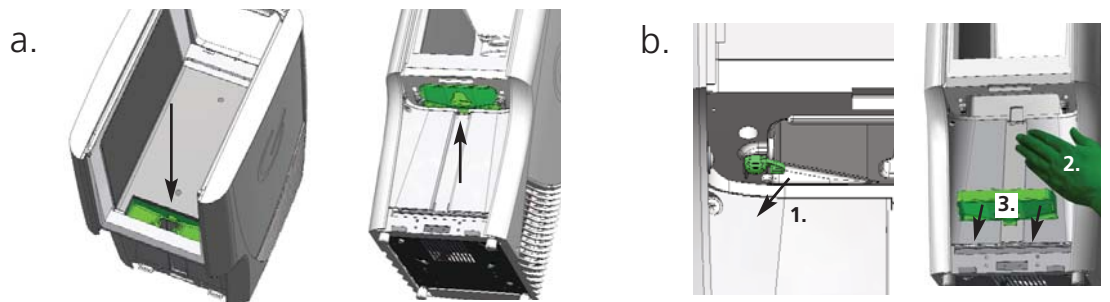

Ensure condensate tray drain is clean and unobstructed.
 Asegúrese que el drenaje de la bandeja condensadora esté limpio y sin obstrucciones.

Remove condensate tray to clean.
 Retire la bandeja de condensación para limpiar.





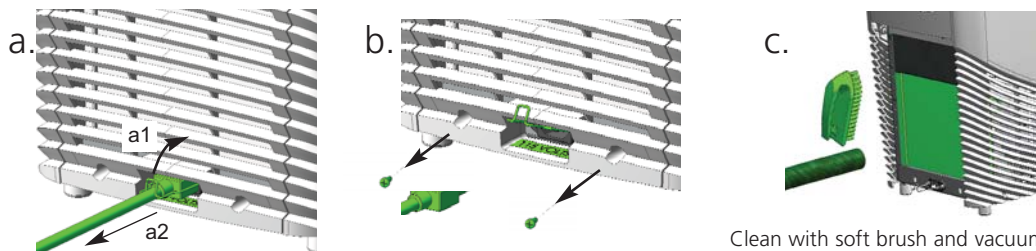



4.

MONTHLY/MENSUAL		1	2	3	4	5
6	7	8	9	10	11	12
13	14	15	16	17	18	19
20	21	22	23	24	25	26
27	28	29	30			

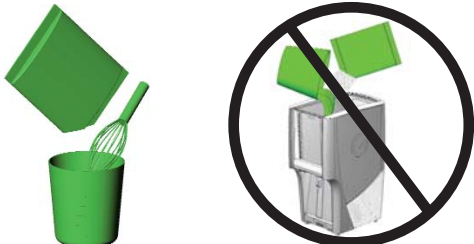

Clean condenser every 1 to 6 months.
 Limpie el condensador cada 1 a 6 meses.

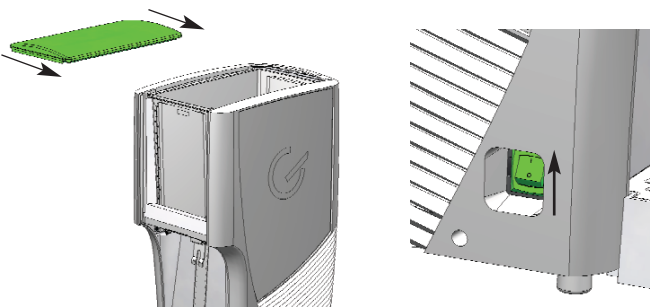

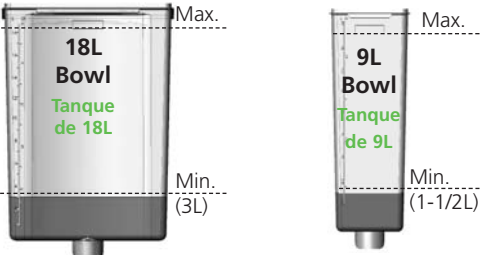





Clean with soft brush and vacuum. Do not deform the thin condenser fins. Damaging the fins will impair the performance of refrigeration system and may void warranty.
 Limpie con una brocha suave y con una aspiradora. No deforme las finas aletas del condensador. Daños a las aletas del condensador deteriora el funcionamiento del sistema de refrigeración y podría anular la garantía.

<p>1.  Wash hands thoroughly when handling dispenser and product. Lávese bien las manos cuando este manipulando el dispensador y el producto.</p> 	<p>2. Mixing tools. Utensilios para mezclar.</p>  <p>Pail Contenedor</p> <p>Wire whisk Batidor</p> <p>Measuring pitcher Jarra de medida</p> <p>Use only clean mixing tools to prepare product. Use solamente utensilios limpios para preparar el producto.</p>
<p>3.</p>  <p>To ensure safe and quality beverage, use only reliable, purified, or potable water source to prepare the product. Para asegurar que la bebida sea sana y de calidad, use solamente agua potable o de una fuente portátil confiable para preparar el producto.</p>	<p>4.</p>  <p>Prepare concentrate by mixing powder with water using wire whisk until completely dissolved. Follow recommended dilution per product label. Prepare el concentrado al mezclar el polvo con agua usando el batidor hasta que esté completamente disuelto. Siga las recomendaciones para diluir presentada en la etique del producto.</p>
<p>5.</p>  <p>Pour concentrate into dispenser and then add remaining water per product label. Vierta el concentrado en el dispensador y agregue el resto del agua indicado en la etiqueta del producto.</p>	<p>6.</p>  <p>Install lid. Instale la tapa.</p> <p>Turn on main power switch. Encienda el equipo.</p>
<p>7.</p>  <p>Correct way to dispense. Manera correcta de dispensar.</p> <p>Incorrect way to dispense. Manera incorrecta de dispensar.</p>	<p>8.</p>  <p>18L Bowl Tanque de 18L</p> <p>9L Bowl Tanque de 9L</p> <p>Max.</p> <p>Min. (3L)</p> <p>Min. (1-1/2L)</p> <p>Always observe minimum 3 liter (18L bowl) or 1-1/2L (9L bowl) fill level to prevent foaming of product at low level. Observe siempre la marca mínima del nivel de llenado de 3 litros (tanque de 18L) ó 1-1/2 litros (tanque de 9L). Se formara espuma en el producto por debajo de este nivel.</p>

Product Handling









Manipulación del Producto

 <p>Check product expiry date on the label. Verifique la etiqueta con la fecha de expiración del producto.</p>	 <p>Follow recommended product preparation and dilution procedure. Siga los procedimientos recomendados de preparación y como disolver el producto.</p>	 <p>Use only reliable, purified or potable water source. Use únicamente agua potable o de una fuente portátil confiable.</p>	 <p>Keep food preparation area, utensils, equipment, and surroundings clean. Mantenga el área de preparación de los alimentos, utensilios, equipo, y alrededores limpias.</p>
 <p>Keep beverage cold or frozen. Harmful germs grow fast between 5°C and 63°C. Mantenga la bebida fría o congelada. Los gérmenes dañinos crecen rápidamente entre 5°C y 63°C.</p>	 <p>Use ice prepared from potable water or purchased from reliable source. Ensure that ice is stored in clean, white container. Use hielo que haya sido preparado con agua potable o comprado de un proveedor confiable. Asegúrese que el hielo sea guardado en un contenedor blanco y que esté limpio.</p>	 <p>Discard after 24 hours. Do not use left over preparation from previous day. Bote luego de 24 horas. No utilice las sobras de lo preparado el día anterior.</p>	 <p>Maintain pest-free surroundings. Do not spray insecticides on food-contact surfaces, i.e., dispenser, preparation area, etc. Mantenga los alrededores libres de insectos. No rocíe insecticidas en superficies para tocar los alimentos, i.e., dispensadores, área de preparación, etc.</p>

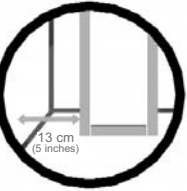
Dispenser Handling

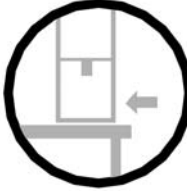





Manejo del Dispensador

 <p>Place dispenser on a stable counter to support its weight. Ubique el dispensador en un mostrador estable que soporte su peso cuando está lleno.</p>	 <p>Allow 13 cm (5") space on sides and 15cm (6") space on back for proper ventilation. Permita un espacio de 13 cm (5") a los lados y de 15 cm (6") atrás para una ventilación apropiada.</p>	 <p>Position the machine away from any heat emitting objects, ie. ovens, grills, etc. Ubique el equipo lejos de cualquier objeto emisor de calor como hornos, asadores, etc.</p>	 <p>Ensure all parts are properly secured and in place before operating the machine to avoid damage. Asegúrese que todas las partes estén fijadas apropiadamente y en su lugar antes de operar la máquina para evitar que se dañe.</p>
 <p>Always observe minimum fill level before operating the dispenser. Observe siempre los niveles mínimos de llenado antes de operar el dispensador.</p>	 <p>Ensure availability of proper washing area. Do not wash dispenser and parts in the restroom/toilet. Asegure que haya disponible un lugar para lavar el equipo. No lave el dispensador y sus partes en el cuarto de baño.</p>	 <p>Do not use extension cord. No use cables de extensión.</p>	 <p>Report broken parts immediately. Reporte las partes dañadas inmediatamente.</p>

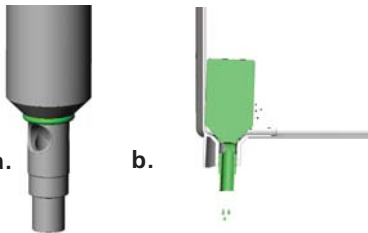
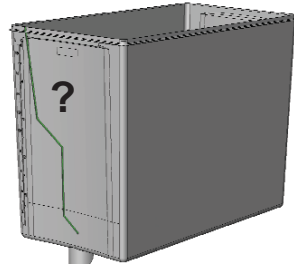

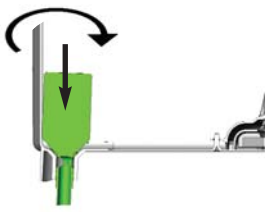
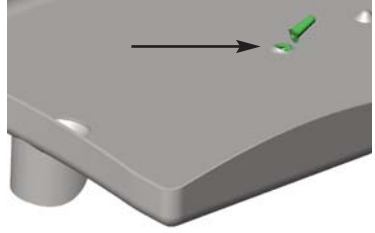
Leaking



Goteo (escape)



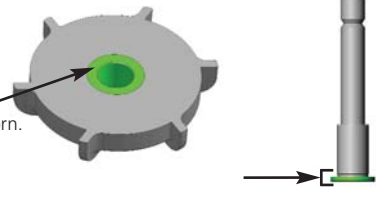
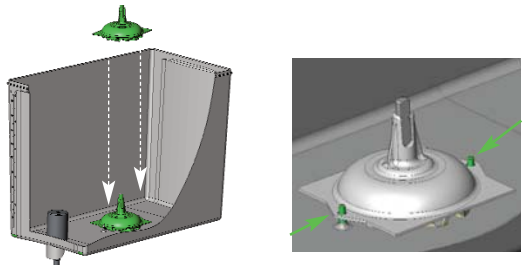
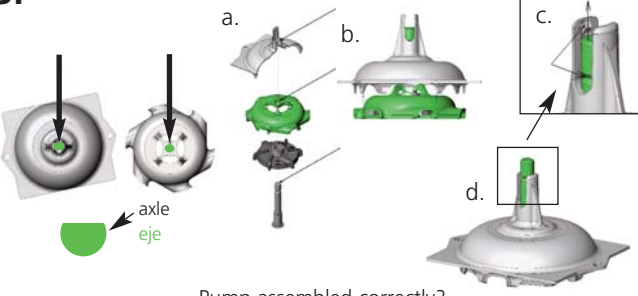

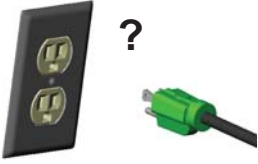
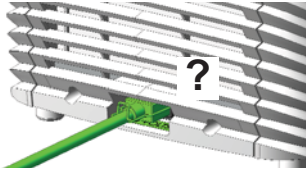
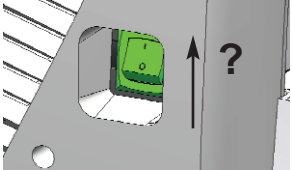

<p>1.</p>  <p>a. O-ring nicked, deformed, or twisted? a. ¿El o-ring está golpeado, astillado o torcido?</p> <p>b. Foreign particles on bowl valve seat? b. ¿Hay partículas extrañas alojadas en la base de la válvula en el tanque?</p>	<p>2.</p>  <p>Cracked bowl? Replace bowl. ¿Está el tanque quebrado/rajado? Reemplace el tanque.</p>	<p>3.</p>  <p>Drain tray overflow? Empty tray. ¿Hay desborde en la bandeja de goteo? Vacee la bandeja.</p>
<p>4.</p>  <p>Valve securely in place? Push and twist to seat. ¿Está la válvula asegurada en su lugar? Empuje y gire en su lugar.</p>	<p>5.</p>  <p>Pin in bowl broke, making a hole. Replace bowl. El punto en tanque se rompe y se hace un hueco. Reemplace el tanque.</p>	<p>6.</p>  <p>The valve is the wrong valve. Use valve with part #99302 on top. Lavalvula esta una valvula equivocada. Use la valvula correcta con el numero 99302 en la parte superior.</p>

No product agitation

No hay Agitación del Producto

<p>1.</p>  <p>Replace impeller if bearing surface is worn. Reemplace el propulsor si el casquillo esta gastado.</p> <p>Replace pump axle if flange thickness is less than .75mm (0.03 inch) thick. Reemplace el eje de la bomba si el grueso del borde es menor que .75mm (0.03 pulgadas).</p> <p>Impeller and/or axle worn? Replace worn parts. See routine maintenance. ¿El propulsor y/o eje están gastados? Reemplace las partes gastadas. Vea la rutina de mantenimiento.</p>	<p>2.</p>  <p>Pump installed correctly in bowl? ¿Está la bomba instalada correctamente en el tanque?</p>
<p>3.</p>  <p>Pump assembled correctly? ¿Está la bomba ensamblada correctamente?</p>	<p>4.</p>  <p>Pump motor magnet needs adjustment? ☎ Call for service? ¿Si el imán del motor de bomba necesita ajustarse? ☎ llame el servicio.</p>

No refrigeration	No hay refrigeración
<p>1.</p>  <p>Plugged in to wall outlet? ¿Conecte a la salida de corriente en la pared?</p>	<p>2.</p>  <p>Plugged in to machine? ¿Conecte a la máquina?</p>
<p>3.</p>  <p>Power switch on? ¿Encienda el interruptor?</p>	<p>4.</p>  <p>Compressor does not run; fan does? ¿El compresor no funciona; el ventilador sí? ☎ Call for service. ☎ Llame para solicitar servicio.</p>
<p>5.</p>  <p>Faulty thermostat? Machine will not operate. ☎ Call for service.</p> <p>¿El termostato está dañado? La máquina no funcionará. ☎ Llame para solicitar servicio.</p>	

Poor refrigeration	Poca refrigeración
<p>1.</p>  <p>Dirty condenser? Clean condenser or ☎ call for service.</p> <p>¿El condensador está sucio? Limpie el condensador o ☎ llame para solicitar servicio.</p>	<p>2.</p>  <p>No product agitation (see pg 10)? El producto no se agita (vea pagina 10)</p>
<p>3.</p>  <p>Evaporator dirty or foreign objects on surface? Ensure evaporator surfaces and bowl surfaces are smooth and clean.</p> <p>¿El evaporador está sucio o hay objetos extraños en la superficie? Asegúrese que la superficie del evaporador y el tanque estén lisas y limpias.</p>	<p>4.</p>  <p>Compressor does not operate; fan does not operate. Faulty fan motor? ☎ Call for service.</p> <p>El compresor no funciona; el ventilador no funciona. ¿ El motor del ventilador esta dañado? ☎ Llame para solicitar servicio.</p>
<p>5.</p>  <p>Impeller does not spin. Faulty pump motor? ☎ Call for service.</p> <p>El propulsor no gira. ¿El motor de la bomba está dañado? ☎ Llame para recibir servicio.</p>	<p>6.</p>  <p>Faulty thermostat or improper setting? ☎ Call for service.</p> <p>¿Está el termostato dañado o el ajuste es inapropiado? ☎ Llame para solicitar servicio.</p>

Noisy machine

La Máquina Hace Ruido

1.

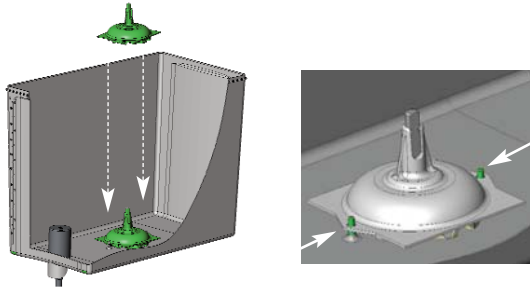

Pump installed correctly in bowl?
¿Está la bomba instalada correctamente?

2.



Bowl or pump installed while unit in "on" position?
Turn unit off. Reinstall parts.
¿Si pone la bomba o el tanque cuando la máquina esta prendida, hace mucho ruido? Apague la máquina. Instale las partes.

3.



Faulty pump motor bearings.
☎ Call for service.

Los casquillos de la bomba están dañados. ☎ Llame para solicitar servicio.



Chattering impeller? Ensure correct drive magnet height or
☎ Call for service.

¿El propulsor golpea?
Asegure que la altura del conductor magnético sea apropiada o
☎ llame para solicitar servicio.

4.

Replace impeller if bearing surface is worn.
Remplace el propulsor si el casquillo esta gastado.

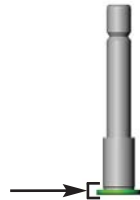
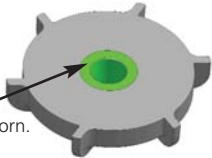

Replace pump axle if flange thickness is less than .75mm (0.03 inch) thick.
Remplace el eje de la bomba si el grueso del borde es menor que .75mm (0.03 pulgadas).

Impeller and/or axle worn? Replace worn parts.
See routine maintenance.

¿El propulsor y/o eje están gastados? Remplace las partes gastadas.
Vea la rutina de mantenimiento.

5.

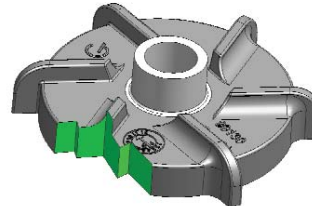

Broken impeller? Replace it.
¿Está el propulsor roto? Reemplacelo.

6.



Fan blade bent?
Unplug unit, remove side panel, inspect fan blade.

¿Están las aspas del ventilador dobladas?
Desconecte la máquina, retire el panel lateral, inspeccione las aspas del ventilador.

Installation and Set-Up
Unpacking Instructions

Instalación y Ajuste Inicial
Instrucciones de Desempacado



! WARNING
Lifting hazard.
 Single person lift could cause injury.
 Use assistance when moving or lifting.



! ATENCIÓN
Cuidado al Levantar.
 Si es levantado por una sola persona puede causar lesión.
 Solicite asistencia cuando mueva o levante.

1.

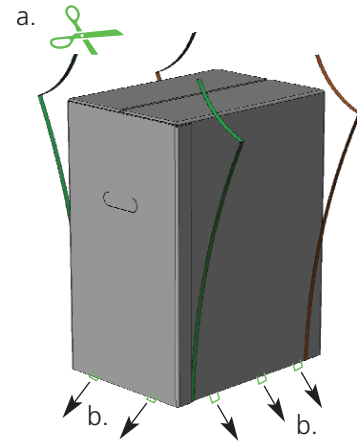

a. Remove band straps.
 b. Remove lower staples.

a. Retire las bandas de soporte.
 b. Retire las grapas inferiores.

2.

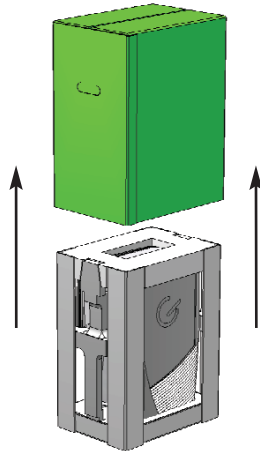

Remove box.
 Retire la caja.

3.

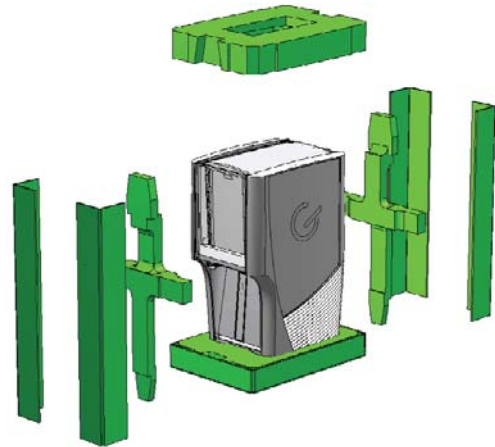

Remove inner pack materials.
 Retire los empaques interiores.

4.

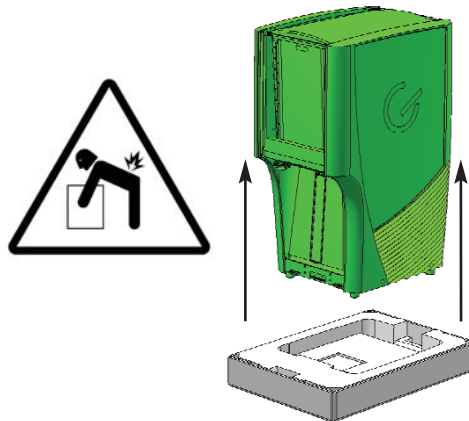

Lift machine from lower shipping pad. Do not lift by panels.
 Lift by bottom of base to prevent damage.
 Separe la base de envío levantando la máquina. No la levante por los paneles. Levántela desde debajo de su base para evitar dañar al equipo.

5. Install legs. Instale las patas.

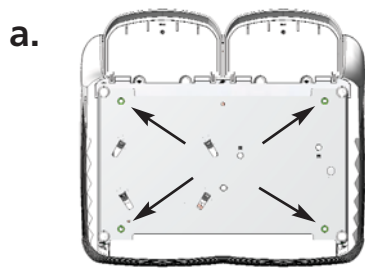

Locate leg holes under machine.
Localice los agujeros abajo de la máquina.

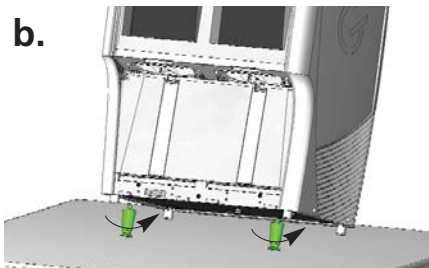

Screw in front two legs.
Atornille las patas del frente.

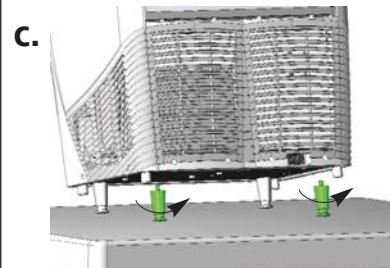

Screw in rear two legs.
Atornille las patas de atrás.

6. Install drip tray bracket. Instale la placa que sostiene las bandejas de goteo.

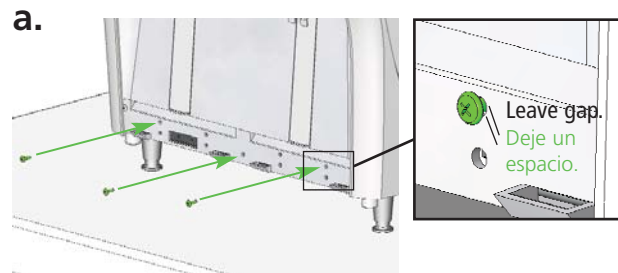

Install 3 screws. Leave gap.
Instale tres tornillos. Deje un espacio.

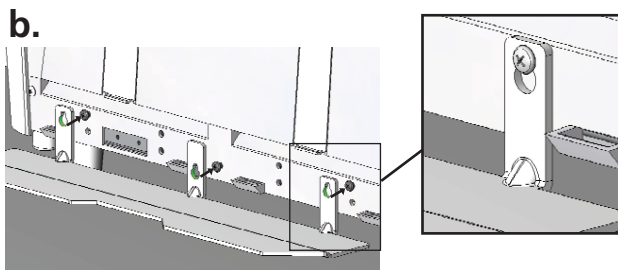

Install bracket onto screws and tighten screws.
Instale la placa en los tornillos y apriételes

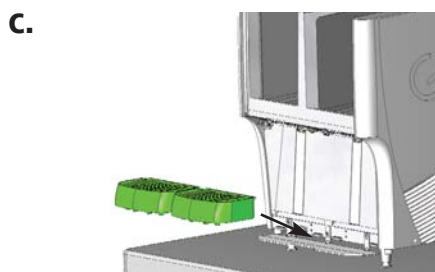

Install drip trays.
Instale las bandejas de goteo.

7. Unpack and install bowl parts and drip pan (see pg. 6). Desempaque e instale las partes del tanque, y la bandeja de goteo (vea pag. 6).

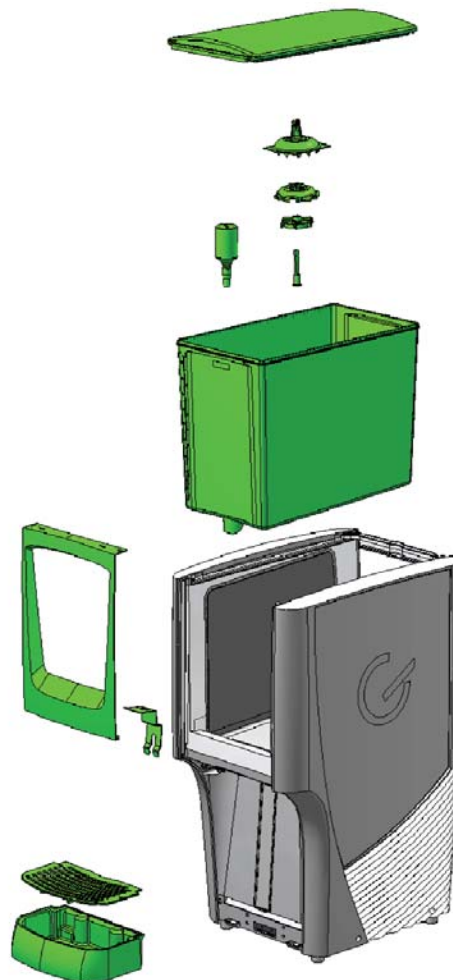

1. Place machine on counter with proper spacing.

Ubique la máquina en un mostrador con el espaciamiento necesario.

a.  Place dispenser on stable counter to support its weight.
Ubique el dispensador en un mostrador estable que pueda soportar su peso cuando está lleno.

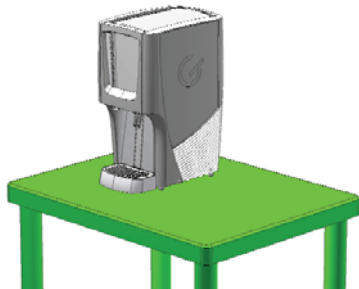

b.  Allow 13cm (5") on sides and 15cm (6") on back for proper ventilation.
Permita 13cm (5") a los lados y 15cm (6") atrás para una ventilación apropiada.

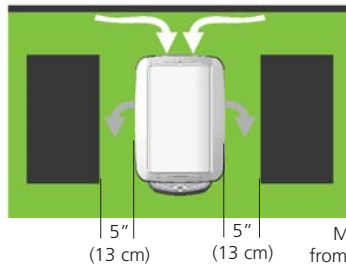

6"
(15 cm)
Minimum machine spacing from wall
Espacio mínimo de la pared a la máquina

5"
(13 cm)
Minimum side spacing from wall or other machines
Espacio mínimo a cada costado de la máquina

c.  Position machine away from heat emitting objects (i.e. ovens, grills, refrigeration equipment).
Ubique el equipo lejos de objetos que emiten calor (i.e. hornos, asadores, equipo de refrigeración).



2. Install power cord.

Instale el cable de energía.

a. Install cord clip.
Instale la grapa de ajuste.

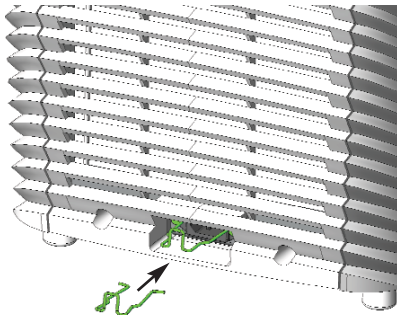

b. Note proper voltage.
Observe la configuración de voltaje.

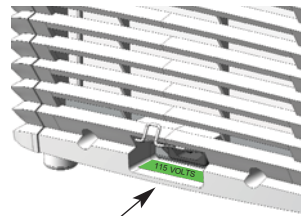

 Observe machine voltage configuration. Do not apply improper voltage to machine or damage to machine will occur.
Observe la configuración de voltaje de la máquina. No aplique un voltaje inapropiado a la máquina o algún daño le ocurrirá a la máquina.

c. Insert power cord into dispenser.
Inserte el cable de energía en el dispensador.

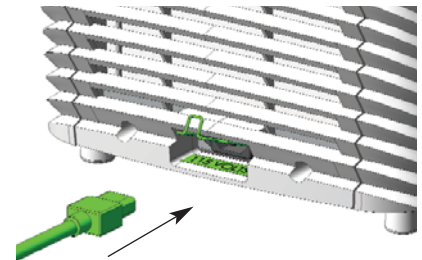

c. Rotate locking clip down.
Mueva la grapa de ajuste hacia abajo.

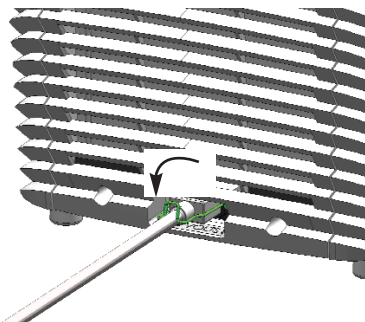

d. Plug cord into power outlet.
Conecte el cable de energía a la toma de corriente.

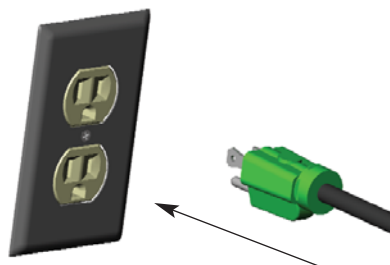

 Do not use extension cord.
No utilice cables de extensión.

 Failure to follow proper installation guidelines can damage equipment and void warranty.
La falta en seguir los lineamientos de instalación apropiados pueden dañar el equipo y anular la garantía.



GRINDMASTER™

C O R P O R A T I O N

Grindmaster® Coffee Grinders and Brewers • Espresso® Espresso Machines • Crathco® Hot Beverage Dispensers
Crathco® Cold and Frozen Beverage Dispensers • American Metal Ware® Coffee and Tea Systems
Tel (502) 425-4776 • Fax (502) 425-4664 • 1-800-695-4500 (USA & Canada only)
P.O. Box 35020 • Louisville, KY 40232 • USA
www.grindmaster.com • email: info@grindmaster.com